



AIR COOLED CHILLER

Model 7500MC

INSTRUCTION MANUAL

January 2011
IMS Company
10373 Stafford Road
Chagrin Falls, OH 44023-5296

Telephone: (440) 543-1615
Fax: (440) 543-1069
Email: sales@imscompany.com
Website: www.imscompany.com

Air-Cooled Water/Glycol Chiller

Capacities

Chiller Capacity:	7.5 ton
@ 65° LFT:	90,000 BTU's/hr
Reservoir Capacity:	60 Gallon

Dimensions

Length:	57 in
Width:	37 in
Height:	70 in
Dry Weight:	570 lbs

Electrical

Volts/Phase:	460/3
Hz:	60
Control Voltage:	115VAC
FLA	24

Misc Specifications

Refrigerant:	R407C
Charge:	15 lbs
Compressor FLA:	16.5
Compressor HP:	7.5
Compressor Type:	Scroll
Water Pump FLA:	3.4
Water Pump HP:	2
Water Pump GPM:	23
Water Pump Pressure:	40 PSI
Inlet/Outlet:	1.25 in

Model: 7500MC-(S/O/W)

Package Options: All packages come with manual bypass and cleanable air filters

MC-S: Standard unit built for indoor use. Glycol solution **MUST** be used. Ambient conditions ranging from 50 - 95 deg F.
- less than 15% glycol solution will result in voided warranty

MC-O: Built for outdoor use in ambient conditions ranging from -20 - 95 deg F. unit will come standard with:
- galvanized sheet metal
- ranco controller
- variable frequency drive (for fan control).

MC-W: Built for use with straight water unit will come standard with:
- Auto Water Fill
- Inlet Water Filter
- Hot Gas Regulator



April 2010
IMS Company
10373 Stafford Road
Chagrin Falls, OH 44023-5296

Telephone: (440) 543-1615
Fax: (440) 543-1069
Email: sales@imscompany.com
Website: www.imscompany.com



MASTERCHILL 7.5TON

INSTALLATION and OPERATION MANUAL

TABLE OF CONTENTS

General Information	3
Introduction and Safety	3
Nomenclature	4
Options Available	5
Installation	6
Basic Components	7
Pre-Start Up Procedure	8
Initial Start-Up and Operating	8
Maintenance and Spare Parts	9
Process Fluid Recommendations	10
Troubleshooting	12
Warranty	14
MSDS	17
Temperature Controller	26
Materials and Unit Specific Drawings	27

GENERAL INFORMATION DESIGN TEMPERATURE & TESTING

Our chiller systems are designed to maintain the temperature of cooling fluids within a selected temperature range. Each of our units is tested and run under load conditions prior to shipping. This enables our experienced technicians to calibrate all instrumentation precisely and verify that each individual unit will function exactly as specified.

The units are designed to operate efficiently within given parameters. Due to varying heat exchange rates outside of design temperature, it is required that the machine operate only at temperatures within 10°F of the specified temperature. **Consult the factory if a process requires changes in excess of 10°F in either direction of design temperature.**

INTRODUCTION:

PURPOSE: The purpose of this manual is to describe the installation, operation and maintenance of the Industrial Molding Supplies (IMS) MasterChill Series Chiller.

SYSTEM DESIGN:

The MasterChill 7.5Ton is a closed loop system with vertical air discharge. The Chiller unit is supplied with a recirculating pump and hermetically sealed compressor. It is also equipped with a thermoplastic reservoir for convenient filling and broad chemical compatibility. The MasterChill can only be used on closed loop systems that do not already contain a tank. These units cannot be used to directly cool cutting fluids or oils. The extra large reservoir provides for a thermal stability effect. The brazed plate heat exchanger is a high turbulence design offering thermal efficiency. The lift out, cleanable air filter(s)

prevents the need for difficult condenser cleaning and ensures proper air flow through condenser. The easy to read digital temperature controller allows for maximum controllability.

This chiller unit is designed to operate at fluid temperatures between 50° and 95° F and ambient temperatures from 50° to 95° F. It comes fully charged with R-407C refrigerant and the data tag on each unit conveys the amount required for the system.

The unit is also offered with several special options that are described in the next section.

If this unit is to be stored for any length of time, be sure to adequately protect against freezing.

NOTE: In this manual, the word 'chiller' will be used to refer to the entire IMS unit.

SAFETY:



CAUTION! Do not attempt to service or repair the cooling unit while in operation. Serious injury or death can occur from electrical shock or exposure to high pressure fluids.

Turn off the main power disconnect and secure any other incoming power source before working on this equipment. Ensure all fluid pressure in the system has been reduced to 0 PSI before performing any work on the unit's fluid systems.

NOMENCLATURE:

Masterchill 7500MC-S - The "S" signifies our standard indoor designed chiller with Carel EZ Controller that requires use of a water/glycol mixture. A manual bypass which allows for adjusting pump output comes standard on this unit. Several options are also available for this unit. Please refer to the options table on page 5 for details.

Masterchill 7500MC-O - The "O" signifies an outdoor unit with galvanized cabinet, variable speed fan and flush-mounted Ranco controller. This unit requires use of a water/glycol mixture. A manual bypass which allows for adjusting pump output comes standard on this unit. A remote controller with 350ft range is optional on this unit. There are several additional options available for this unit. Please refer to the options table on page 5 for details.

Masterchill 7500MC-W - The "W" represents our welding/straight water package units. These units are only available for indoor use and are designed to run on water. A manual bypass which allows for adjusting pump output comes standard on this unit. Also included are a hot gas regulator to ensure freeze protection, an auto water fill valve, and an inlet water filter. Several additional options are available for this unit. Please refer to the options table on page 5 for details.

OPTIONS:

The following options list represents the complete list of standard options offered. Not all options are available on each unit. Please refer to the options chart on the following page to see which standard options are available for your unit. If your process requires a special application, please contact the factory for pricing of non-standard options/models.

Automatic Water Level Control (make up water valve)- Standard on the W unit and an option on the S unit, this option allows for automatic fluid feed from a reverse osmosis supply or from plant water system and is used to maintain the water level of the reservoir. Please refer to the installation section for additional details.

Hot Gas Regulator- Weld/Straight Water (W) units are equipped with a hot gas regulator to protect the unit from freezing. *(Note: This is NOT a hot gas bypass which can increase electrical costs. The regulator runs only when unusual conditions warrant).* As this unit is the only one equipped for straight water use, this feature is only available on this model.

Inlet Water Filter- Standard on the W unit and optional on both the O and S units, this option is a filter for the return line from the equipment, designed to keep debris from entering the chiller unit. The filter kit is shipped loose with the unit and includes the housing and two filter cartridges.

Pressure Relief- Available on all units, a pressure relief provides an outlet for the process pump in case of blockage, preventing potential damage to additional components.

Anti-BackFlow Kit- Available on all units, this feature prevents any backflow through the chiller when the chiller is turned off. This option is used in situation where the chiller is installed below the processing equipment. It can also be used in an installation where overhead piping creates a backflow potential. This option is shipped loose and will require installation.

Stainless Cabinet- A Brushed finish stainless cabinet is available on all models.

Pump Upgrade- A pump upgrade is available on all units for higher pressure applications. 60 and 80 psi pumps are available which provide increased pressure to the unit.



Options Available: MasterChill STANDARD Unit (MC-S)

	Auto Fill	Hot Gas Regulator	Inlet Filter	Pressure Relief Bypass	Back Flow Kit	230/1/60 230/3/60 460/3/60	Casters	Stainless Cabinet	Pump Upgrades Avail	Remote Control Panel
2TON	O		O	O	O	all available	O	O	60 or 80psi	
3TON	O		O	O	O	230/3/60 or 460/3/60	O	O	60 or 80psi	
5TON	O		O	O	O	230/3/60 or 460/3/60	O	O	60 or 80psi	
7.5TON	O		O	O	O	460/3/60		O	60 or 80psi	
10TON	O		O	O	O	460/3/60		O	60 or 80psi	
15TON	O		O	O	O	460/3/60		O	60 or 80psi	
20TON	O		O	O	O	460/3/60		O	60 or 80psi	

Options Available: MasterChill WELDING/STRAIGHT WATER Unit (MC-W)

	Auto Fill	Hot Gas Regulator	Inlet Filter	Pressure Relief Bypass	Back Flow Kit	230/1/60 230/3/60 460/3/60	Casters	Stainless Cabinet	Pump Upgrade	Remote Control Panel
2TON	S	S	S	O	O	all available	O	O	60 or 80psi	
3TON	S	S	S	O	O	230/3/60 or 460/3/60	O	O	60 or 80psi	
5TON	S	S	S	O	O	230/3/60 or 460/3/60	O	O	60 or 80psi	
7.5TON	S	S	S	O	O	460/3/60		O	60 or 80psi	
10TON	S	S	S	O	O	460/3/60		O	60 or 80psi	
15TON	S	S	S	O	O	460/3/60		O	60 or 80psi	
20TON	S	S	S	O	O	460/3/60		O	60 or 80psi	

Options Available: MasterChill OUTDOOR Unit (MC-O)

	Auto Fill	Hot Gas Regulator	Inlet Filter	Pressure Relief Bypass	Back Flow Kit	230/1/60 230/3/60 460/3/60	Casters	Stainless Cabinet	Pump Upgrade	Remote Control Panel
2TON			O	O	O	all available		O	60 or 80psi	O
3TON			O	O	O	230/3/60 or 460/3/60		O	60 or 80psi	O
5TON			O	O	O	230/3/60 or 460/3/60		O	60 or 80psi	O
7.5TON			O	O	O	460/3/60		O	60 or 80psi	O
10TON			O	O	O	460/3/60		O	60 or 80psi	O
15TON			O	O	O	460/3/60		O	60 or 80psi	O
20TON			O	O	O	460/3/60		O	60 or 80psi	O

O= Optional

S= Standard (Included)

CHILLER SPECIFICATIONS:

MasterChill	Electrical	BTU/hr. 65F (LFT)	Pump HP HP	Flow GPM	Pressure PSI	Rated FLA Amps	Reservoir US Gal	Length in	Width in	Height in	Piping FPT	Dry Weight lbs.
2000	230/1/60	24,000	0.5	10	35	21	10	31	28	50	1	460
	230/3/60	24,000	1	10	35	20	10	31	28	50	1	460
	460/3/60	24,000	1	10	35	10	10	31	28	50	1	460
3000	230/3/60	36,000	2	10	44	26	36	37	34	70	1.25	540
	460/3/60	36,000	2	10	44	13	36	37	34	70	1.25	540
5000	230/3/60	60,000	2	15	43	35	36	37	34	70	1.25	570
	460/3/60	60,000	2	15	43	17.5	36	37	34	70	1.25	570
7500	460/3/60	90,000	2	23	40	24	60	57	37	70	1.25	1350
10000	460/3/60	120,000	2	30	36	33	60	57	37	70	1.25	1350
15000	460/3/60	180,000	3	60	45	42	100	60	57	74	2	1800
20000	460/3/60	240,000	3	60	45	53.4	100	60	57	74	2	2500

INSTALLATION:

1. Read and follow all information included with the chiller manual.
2. Read and understand all warning labels and tags on the chiller before installation.
3. Ensure the unit is placed on a flat, level, hard surface. Unless the chiller has been built for outdoor operation, it must be placed indoors. Space above and around the unit must be capable of dissipating the heat rejected by the chiller and allow room for servicing. Keep the unit at least 3ft away from walls or other objects and allow full access to all openings and electrical enclosures. At a minimum, 8ft of clearance is required above the unit for proper air circulation around the chiller as shown in Fig 1.

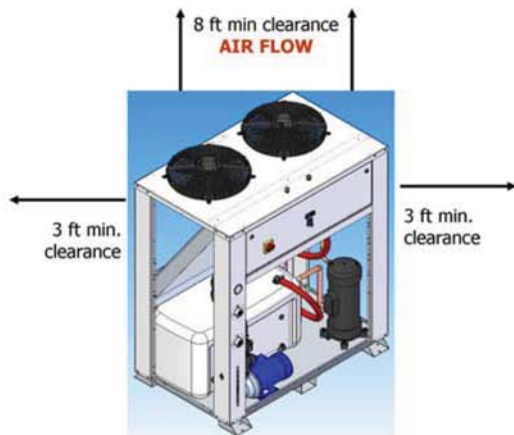

Figure 1. Minimum Installation Clearances

4. Field piping size should be adequate to match fluid flow to the system, typically no smaller than the size of the chiller fittings.
5. For W units (or S and O that purchased the option) an inlet filter is shipped loose from the factory. Connect to the unit now by attaching to the fitting on the control leg.
6. Connect process fluid lines to the proper fittings marked "FLUID INLET TO CHILLER" and "FLUID OUTLET FROM CHILLER". **DO NOT OVERTIGHTEN.** Ensure that the flow of fluid to and from the unit cannot be shut off or blocked while the chiller is in operation unless the pressure relief option was purchased.
7. For W units (or S and O that purchased the option) connect make-up fluid to automatic water level control. Plumb directly to the port which is located on the control leg.
8. Fill the reservoir with the proper type and amount of fluid. The fluid temperatures added to the unit should never exceed 130°F. Refer to the "Process Fluid Recommendations" section (page 10) of the manual for glycol recommendations and information regarding the use of water in the W unit.



Note: S and O units are designed for glycol use only. Use of straight water will compromise the brazed plate heat exchanger and void the warranty.

9. Purge any air out of the fluid system to ensure that the pump suction is flooded. Bleed any air trapped in the pump by opening the vent plug

at the top of the pump until no more air comes out and fluid is present in the pump cavity.



DO NOT ALLOW THE FLUID PUMP TO RUN DRY. THIS WILL DAMAGE THE PUMP SEALS AND WILL NOT BE COVERED UNDER WARRANTY.

10. Run power wiring to the chiller's main disconnect. Conductor size should match the chiller's disconnect size and power requirements in accordance with local codes. Ensure the power supplied matches the chiller data plate requirement for voltage, frequency, and amperage.

11. All units are shipped with the proper refrigerant charge in place. No adjustments should be necessary to the refrigeration system before startup. Refrigeration service valves are shipped in the open (back-seated) position.

12. If remote ducting is preferred on your indoor unit, we recommend that you contact a local HVAC professional to determine proper sizing for your installation. A booster fan may also be required.

BASIC COMPONENTS:

Refer to Figure 2 for identification of the main parts on a standard MasterChill Series Chiller. Please note that this is only a general representation of components and depending on size and options, your model will differ from the design shown.

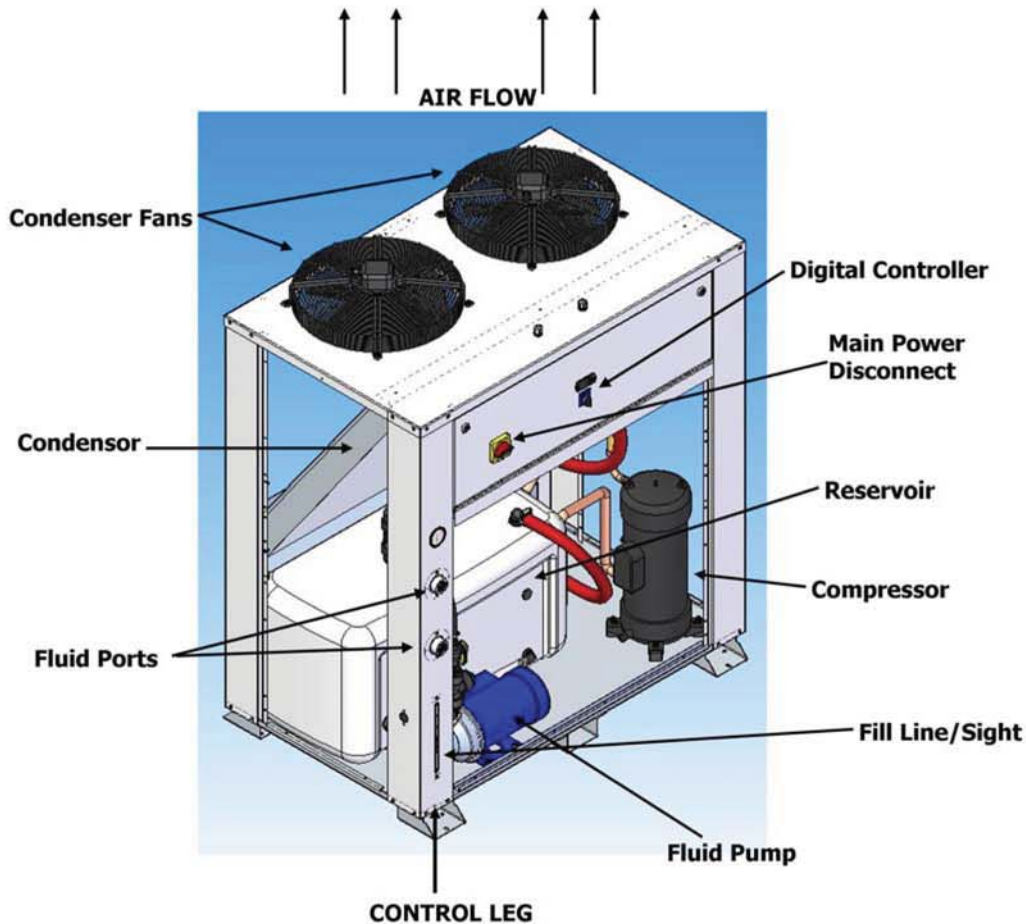

Figure 2. Basic MasterChill Components

PRE-STARTUP PROCEDURE:

1. Complete all steps of the *installation* process before applying power to the chiller.
2. Ensure the system switch is in the OFF position, then turn on the main power disconnect.
3. Chillers 2 tons or larger are equipped with a compressor crankcase heater. **These units must have power supplied to the unit with only the disconnect switch on for 8 hours prior to starting the chiller** and the on/off switch in the *off* position. If power is lost to the chiller or the main disconnect is in the *off* position for more than 30 minutes but less than 2 hours, the chiller must have power supplied to the unit with only the disconnect switch on for 4 hours prior to restarting the chiller. If power is lost to the chiller or the main disconnect is in the *off* position for more than 2 hours, the chiller must have power supplied to the unit with only the disconnect switch on for 8 hours prior to restarting the chiller. For power loss of less than 30 minutes, no reheat is needed. This will raise the temperature of the compressor oil enough to vaporize any refrigerant that may be in the crankcase oil. **Failure to allow this warm-up can result in compressor damage and void the warranty.**



4. Ensure all process fluid lines and shutoff valves are open and the system is able to flow freely. Re-check the fluid level in the system before continuing with the startup.
5. **For units that run on three-phase power phase rotation must be checked and corrected to avoid damaging the chiller and voiding the warranty.**



All motors within the chiller are synchronized at the factory for proper rotation. If one motor is turning in the wrong direction, all other motors will as well. **DO NOT** change the orientation of any motor leads within the chiller. If phase rotation is incorrect, shut off the power feed and change any two incoming power leads **BEFORE** the main disconnect.

Phase rotation can be checked by briefly turning on the system (less than 2 seconds) and allowing the process pump to energize. Watch the rotation of the cooling fan on the pump to see that it is turning in the direction indicated by the rotation arrow on the pump motor. Do not use condenser fans to judge phase rotation as many three phase units have single phase fans and will run correctly from IMS even with incorrect power phasing.

As an alternate method, a phase checking device can be used to check power at the disconnect. All components of the chiller are wired to operate with a "right-hand" phase rotation.

INITIAL STARTUP & OPERATING PROCEDURE:

1. Complete all steps of the *pre-startup procedure* before starting the chiller process.
2. Before turning on the chiller system, become familiar with the operation of the temperature controller on the chiller. Refer to the *temperature controller section* in this manual for instructions.
3. Turn on the chiller process at the selector switch. *Note: Some outdoor units have a REMOTE option. If the unit is wired to start remotely, turn the switch to ON and initiate the process from the remote location.*

The process pump will energize and produce flow as soon as the chiller is turned on. Monitor any system pressure gauges and make note of initial pressures.

4. Check the entire fluid system for leaks and ensure there is flow throughout the system.
5. After the pump turns on, the temperature controller will then analyze the process fluid temperature and determine whether or not cooling is needed. If the fluid temperature is above setpoint, the refrigerant compressor will start and begin cooling the fluid.
6. Monitor the chiller to ensure it is performing as designed. The chiller should be able to maintain the desired fluid setpoint under a full load from the process. Please consult a

technician at Industrial Molding Supplies before making any changes to the unit.

- To turn off the chiller process, move the selector switch to the OFF position. With the selector OFF, the temperature controller display will continue to monitor the temperature process, but indicate the system is off. **Keep the chiller's main power-disconnect ON even when the chiller is not in use.** This keeps the power to the crankcase heater and prevents compressor damage when restarting the unit.



MAINTENANCE AND SPARE PARTS:

Proper maintenance is the key to extending the life of your chiller. Routine checks and a watchful eye will minimize costly repairs and down time. Establish a regular schedule of maintenance depending on the amount the chiller is used and the environment in which it is used. Environments that are very dirty or dusty will require more attention than ones that maintain a cleaner atmosphere.

This list of maintenance items will help to ensure an operational chiller. The maintenance schedule for each item is merely the recommended minimum and may vary according to your units' environment.

1. Inspect and clean condenser / air filters

(Recommended frequency varies highly with environment - weekly, monthly)



To ensure optimal performance the filters and condenser must be kept clean and free flowing. The condenser is the "radiator" like coil that the fans pull the air through. It is located behind the air filter. Excessive buildup of dirt, oil, and other debris on the condenser coil will cause refrigerant pressures to increase and not allow the unit to perform to its full capacity.

Ensure the fins of the condenser are clean and not damaged to keep airflow at a maximum. Lock-out the unit before removing the door on the back side of the condenser. This door is on the opposite side of the unit from the air filter. Use compressed air at no more than 30 psi to blow out the condenser in the opposite direction of air flow.

Remove and clean air filter with compressed air or wash with water and allow to dry before reinstallation.

2. Check water quality (monthly)

The process fluid should be clean and free of contaminants. Check for debris or contaminants which could reduce the efficiency of your chiller. **Contaminated water may plug the brazed plate heat exchanger which is not covered under warranty.**

3. Test Glycol Mixture (monthly)

For component protection from corrosion and temperature, test the mix to ensure adequate ratios of glycol. A refractometer is available through our parts department. See process fluid recommendations on page 10 for more details.

4. Fluid Pressures (at least monthly)

Check for normal outlet fluid pressures.

5. Inspect fluid strainer (every six months)

There is a strainer located in the return line from process into the chiller, right before the heat exchanger; inspecting it should be a regular part of the maintenance program. Fluid strainers should be unobstructed to allow for proper flow and pressure in the system. An increased fluid pressure on the system may indicate a dirty strainer. Maintenance should be done at regular intervals to keep the fluid system clean and free flowing. Clean after bringing the chiller online to clear any debris from initial use.

6. Replace inlet water filter (if equipped) - (annually)

This filter on the return line from the equipment contains a replaceable cartridge and should be inspected and replaced at regular intervals. This filter should be changed after system start-up.

7. Inspect Fluid System (annually)

Visually check for fluid leaks throughout system. Physically check for loose pipe fittings or hoses. Ensure that no plumbing parts are wearing, cracking, or chafing.

8. Check voltage and amp draws (annually)

Check for proper incoming voltage (+/- 10% of chiller nameplate) and current draws on all motors and heaters. Refer to the chiller's electrical schematics or the motor nameplate for proper voltage and amperage ratings.

9. Inspect mechanical components (annually)

Check mechanical components of the chiller for signs of wear or over-heating. Metallic sounds or other excessive noise could indicate a problem with the chiller. Discolored paint or metal could be a sign of a motor under excessive load and over-drawing current. Keep all components with lubrication fittings properly filled according to the nameplate data or information tag.

10. Check all wiring (3-6 months after start-up and annually thereafter)

Ensure the chillers main power disconnect is OFF. Check the electrical box and all junction boxes for any loose or damaged wiring. Replace any wiring that could cause problems with shorting or unintentional grounds.

11. Inspect/test refrigeration system (annually)

Check the inside of the chiller for evidence of refrigerant leaks. Spots of oil inside of the chiller or refrigeration lines covered in oil could indicate a leak. Have a certified refrigeration technician check the refrigeration system for proper operation. The technician should leak check the unit, monitor operating pressures, and adjust as needed.

PROCESS FLUID RECOMMENDATIONS:



The MasterChill O and S units are designed for use with a water/glycol mixture only. Use of water alone in these units may cause freezing in the brazed plate heat exchanger and will void your warranty.

The W unit is designed for filtered water but a glycol blend is also an option.

The Advantages of a Glycol Blend:

The main job of glycol is to prevent freezing of the process fluid and ensure consistent flow at the operating temperature. Inhibited glycols will also prevent formation of scale and corrosion while protecting metals such as brass, copper, steel, cast iron, and aluminum. Water systems treated with inhibited glycol will also be protected from algae and bacteria that can grow and degrade the fluid system performance. **Ethylene** and **Propylene** are the two standard types of inhibited glycols that can be used in IMS chillers.

Note: Though a 9% blend is all that might be required for freeze protection, a minimal 25% blend is required for rust prevention, anti-algae and other residual benefits. See chart on following page for application recommendations.

ETHYLENE GLYCOL:

Ethylene glycol is the standard heat-transfer fluid for most industrial applications. This type of glycol can be used in any application where a low-toxicity content is not required. Ethylene glycol has moderately acute oral toxicity and should not be used in processes where the fluid could come in contact with potable water, food, or beverage products.

PROPYLENE GLYCOL:

Propylene glycol maintains generally the same freeze protection and corrosion and algae prevention as ethylene glycol, but has a lower level of toxicity. This type of glycol is more readily disposable than ethylene, and safer to handle. Propylene glycol is commonly used in the food industry and in applications where the user may come in frequent contact with the fluid.

Special Considerations:

1. Do not mix different types or brand names of glycol as this can result in some inhibitors precipitating out of the solution.
2. Do not use automotive grade anti-freeze in the chiller process. These types of glycols are not designed for industrial applications and may cause problems with heat transfer or fluid flow. Many automotive glycols contain silicate-based inhibitors that can coat heat-exchangers, attack pump seals, or form a flow restricting gel.

Note: Be sure to check state and local codes when selecting the process fluid. Certain areas may have environmental regulations concerning the use and disposal of glycol or other additives.

WATER:

Water is used as both a blend with the glycol and as a stand-alone fluid in the W units. When selecting the water, use a good quality, filtered source that meets the requirements of the process machine manufacturer. Industrial Molding Supplies recommends the use of **distilled** or **reverse-osmosis** water for the water / glycol mixture.

De-ionized water has the capacity to corrode components and a maintained solution should not be used in any MasterChill unit. This unit can be filled with de-ionized water initially, as long as the di level is not maintained. Damage caused by the use of maintained de-ionized water in a chiller not designed for it will not be covered under warranty.

The use of regular **tap water** is also not recommended. Water from the "city" or "ground" contains deposits and additives which can decrease component life and increase maintenance time.

RATIO OF THE BLEND:

The location of the chiller and environmental concerns must be taken into account when selecting the proper mixture of glycol and water for the chiller process. A process which is located completely indoors and has no chance of freezing will require less glycol than a system located outdoors where low temperatures can cause the fluid to freeze and piping to burst. Applications that have a low operating temperature (below 55°F) should use a glycol mixture equivalent to an outdoor system.

The glycol percentage figures in the chart below will help determine the recommended mixture depending on application and location of the process and will apply to any brand of ethylene or propylene glycol.

APPLICATION	GLYCOL %	WATER %	FREEZE PROTECTION	BURST PROTECTION
Indoor chiller and process	30	70	5°F / -15°C	-20°F / -29°C
Outdoor chiller / Low fluid temperature system (<55°F)	50	50	-35°F / -37°C	-60°F / -60°C

FLUID MAINTENANCE / FILTRATION:

Maintaining clean process water and the proper glycol content will extend the life of the system and reduce costly down-time. The chiller is not equipped with a fluid filter from the factory. It is highly recommended that a filtering system is installed to remove unwanted dirt and debris. Refer to the *Chiller Maintenance* section of the manual for water and filter maintenance information.

TROUBLESHOOTING GUIDE:

- This guide should serve as a general outline for troubleshooting issues with all Industrial Molding Supplies chillers. Due to the various models of IMS chillers, the items listed in *possible causes* may not apply to every IMS chiller.
- Refer to the *Warranty Procedures* section of this manual before having any work performed on units that are under warranty.

PROBLEM	POSSIBLE CAUSE	CORRECTIVE ACTION
Chiller will not turn on. (No display on temperature controller)	<ol style="list-style-type: none"> 1. No power to chiller. 2. Main disconnect turned off. 3. Blown fuses. 4. Tripped starter overloads. 	<ol style="list-style-type: none"> 1. Check power feed to chiller. 2. Turn on main disconnect. 3. Check for and replace blown fuses. 4. Reset any tripped overloads and test affected equipment.
Chiller turns on but nothing happens. (Display is on but no pump or cooling cycle)	<ol style="list-style-type: none"> 1. Selector switch not turned on. 2. Remote signal not active. 3. Fault present within chiller. 4. Fluid pump not operating. 5. Blown fuses. 6. Low tank level. 7. Phase rotation incorrect. 	<ol style="list-style-type: none"> 1. Turn selector switch to ON or LOCAL. 2. Check remote connection for signal. 3. Determine fault and clear if possible. 4. Check pump overload and power to contactor. 5. Check and replace fuses. 6. Check reservoir level and fill as necessary. 7. Correct phase rotation at main disconnect.
Fluid pump is on but does not create required pressure or flow.	<ol style="list-style-type: none"> 1. No fluid present at pump suction. 2. Pump discharge closed or blocked. 3. Strainer is dirty 4. Fluid line size too small. 5. Pump / fluid system is air-bound. 6. Phase rotation incorrect. 	<ol style="list-style-type: none"> 1. Check reservoir level and ensure there is fluid at the pump's suction. 2. Ensure all fluid lines are open to flow. 3. Clean fluid and change strainer. 4. Up-size fluid lines outside of chiller. 5. Vent pump cavity to flood the suction. 6. Correct phase rotation at main disconnect.
Fluid pump is operational but the refrigerant compressor will not run.	<ol style="list-style-type: none"> 1. Fluid temp is below setpoint. 2. Inadequate fluid flow. 3. Low refrigerant pressure. 4. High refrigerant pressure. 5. Blown fuses to compressor. 6. Internal overload tripped. 	<ol style="list-style-type: none"> 1. Allow fluid system to increase in temperature. 2. Correct fluid system to establish flow. 3. SEE "Low refrigerant fault" section. 4. SEE "High refrigerant fault" section. 5. Check and replace blown fuses. 6. SEE "Compressor overload" section.
Chiller is running but does not maintain the desired fluid temp.	<ol style="list-style-type: none"> 1. Fault present within chiller. 2. Phase rotation incorrect. 3. Fluid or heat exchanger is dirty. 	<ol style="list-style-type: none"> 1. Determine fault and clear if possible. 2. Correct phase rotation at incoming power. 3. Replace fluid and clean fluid system.

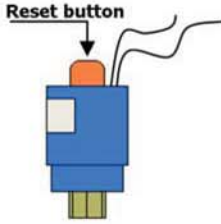
	<ol style="list-style-type: none"> 4. Loss of flow or fluid level. 5. Low refrigerant pressure. 6. Ambient temperature too high. 7. Heat load exceeds chiller's capacity. 	<ol style="list-style-type: none"> 4. Check fluid system for free flow and ensure chiller has adequate fluid level. 5. Restart chiller or clear fault on controller. SEE "low refrigerant fault" section. 6. Ensure chiller is operating within its designed ambient temperature specification. 7. Reduce heat load to chiller if possible. Check the factory specifications to ensure the chiller is not being operated more than +/- 10°F of nameplate setpoint or fluid flow.
<p>Low refrigerant pressure fault - (Automatically reset when satisfied with pressure)</p>	<ol style="list-style-type: none"> 1. Low ambient air temperature. 2. Loss of fluid flow through evaporator. 3. Loss of refrigerant. 4. Refrigerant solenoid not functional. 5. Faulty pressure switch. 6. Compressor crankcase not warm or faulty crankcase heater. 	<ol style="list-style-type: none"> 1. Ensure chiller is operating within its designed ambient temperature specification. 2. Check fluid flow and ensure evaporator is clean. 3. Have a refrigerant technician leak check unit and charge with the appropriate refrigerant. 4. Check wiring to solenoid or replace valve. 5. Replace pressure switch. 6. Ensure main power disconnect has been on for at least 8 hours prior to use. Replace crankcase heater if faulty.
<p>High refrigerant pressure fault -</p>  <p>(Example of a high pressure switch shown)</p>	<ol style="list-style-type: none"> 1. Air filters dirty. 2. Condenser dirty. 3. Incoming air too hot. 4. Inoperative fans. 5. Back panel out of chiller. 6. Phase rotation incorrect. 7. Refrigerant system overcharged. 	<ol style="list-style-type: none"> 1. Clean filters (See maintenance section). 2. Clean condenser (See maintenance section). 3. Ensure the chiller is properly ventilated with fresh air not exceeding nameplate setpoint. 4. Check for blown fan fuses or faulty fan motor. 5. Ensure all covers and panels are installed. 6. Correct phase rotation at incoming power. 7. Have a refrigeration technician ensure the system is properly charged.
<p>Compressor overload - (Automatically reset)</p>	<ol style="list-style-type: none"> 1. Compressor running too hot. 2. Temperature setpoint too high. 3. Refrigerant pressures too high or low. 4. Low voltage to chiller. 5. Defective compressor. 	<ol style="list-style-type: none"> 1. Allow compressor to cool, then restart unit. 2. Move temperature setpoint to +/- 10°F of factory setpoint. 3. Have a refrigeration technician monitor pressures and determine cause. 4. Correct incoming voltage. 5. Replace compressor.



The MSDS format adheres to the standards and regulatory requirements of the United States and may not meet regulatory requirements in other countries.

DuPont
Material Safety Data Sheet

Page 1

"SUVA" 407C
6037FR Revised 29-AUG-2001

CHEMICAL PRODUCT/COMPANY IDENTIFICATION

Material Identification

"SUVA" is a registered trademark of DuPont.

Corporate MSDS Number : DU005999

Tradenames and Synonyms

"SUVA" 9000

Company Identification

MANUFACTURER/DISTRIBUTOR

DuPont Fluoroproducts
1007 Market Street
Wilmington, DE 19898

PHONE NUMBERS

Product Information : 1-800-441-7515 (outside the U.S.
302-774-1000)
Transport Emergency : CHEMTREC 1-800-424-9300 (outside U.S.
703-527-3887)
Medical Emergency : 1-800-441-3637 (outside the U.S.
302-774-1000)

COMPOSITION/INFORMATION ON INGREDIENTS

Components

Material	CAS Number	%
PENTAFLUOROETHANE (HFC-125)	354-33-6	25
	811-97-2	
ETHANE, 1,1,1,2-TETRAFLUORO- (HFC-134a)		52
DIFLUOROMETHANE (HFC-32)	75-10-5	23

HAZARDS IDENTIFICATION

Potential Health Effects

Inhalation of high concentrations of vapor is harmful and may cause heart irregularities, unconsciousness, or death. Intentional misuse or deliberate inhalation may cause death without warning. Vapor reduces oxygen available for breathing and is heavier than air. Liquid contact can cause frostbite.

(HAZARDS IDENTIFICATION - Continued)

HUMAN HEALTH EFFECTS:

Overexposure to the vapors by inhalation may include temporary nervous system depression with anesthetic effects such as dizziness, headache, confusion, incoordination, and loss of consciousness. Higher exposures to the vapors may cause temporary alteration of the heart's electrical activity with irregular pulse, palpitations, or inadequate circulation. Gross overexposure may be fatal. Skin contact with the liquid may cause frostbite.

Individuals with preexisting diseases of the central nervous or cardiovascular system may have increased susceptibility to the toxicity of increased exposures.

Carcinogenicity Information

None of the components present in this material at concentrations equal to or greater than 0.1% are listed by IARC, NTP, OSHA or ACGIH as a carcinogen.

FIRST AID MEASURES

First Aid

INHALATION

If inhaled, immediately remove to fresh air. Keep person calm. If not breathing, give artificial respiration. If breathing is difficult, give oxygen. Call a physician.

SKIN CONTACT

Flush area with lukewarm water. Do not use hot water. If frostbite has occurred, call a physician.

EYE CONTACT

In case of contact, immediately flush eyes with plenty of water for at least 15 minutes. Call a physician.

INGESTION

Not a probable route. However, in case of accidental ingestion, call a physician.

Notes to Physicians

THIS MATERIAL MAY MAKE THE HEART MORE SUSCEPTIBLE TO ARRHYTHMIAS. Catecholamines such as adrenaline, and other compounds having similar effects, should be reserved for emergencies and then used only with special caution.

FIRE FIGHTING MEASURES

Flammable Properties

Flash Point : No flash point

Flammable Limits in Air, % by Volume:

LEL : None per ASTM E681

UEL : None per ASTM E681

Autoignition: Not determined

Fire and Explosion Hazards:

Cylinders may rupture under fire conditions. Decomposition may occur.

Contact of welding or soldering torch flame with high concentrations of refrigerant can result in visible changes in the size and color of torch flames. This flame effect will only occur in concentrations of product well above the recommended exposure limit, therefore stop all work and ventilate to disperse refrigerant vapors from the work area before using any open flames.

R-407C is not flammable in air at temperatures up to 100 deg C (212 deg F) at atmospheric pressure. However, mixtures of R-407C with high concentrations of air at elevated pressure and/or temperature can become combustible in the presence of an ignition source. R-407C can also become combustible in an oxygen enriched environment (oxygen concentrations greater than that in air). Whether a mixture containing R-407C and air, or R-407C in an oxygen enriched atmosphere becomes combustible depends on the inter-relationship of 1) the temperature 2) the pressure, and 3) the proportion of oxygen in the mixture. In general, R-407C should not be allowed to exist with air above atmospheric pressure or at high temperatures; or in an oxygen enriched environment. For example: R-407C should NOT be mixed with air under pressure for leak testing or other purposes.

Experimental data have also been reported which indicate combustibility of HFC-134a, a component in this blend, in the presence of chlorine.

Extinguishing Media

As appropriate for combustibles in area.

Fire Fighting Instructions

Cool cylinder with water spray or fog. Self-contained breathing apparatus (SCBA) is required if cylinders rupture and contents are released under fire conditions. Water runoff should be contained and neutralized prior to release.

ACCIDENTAL RELEASE MEASURES

Safeguards (Personnel)

NOTE: Review FIRE FIGHTING MEASURES and HANDLING (PERSONNEL) sections before proceeding with clean-up. Use appropriate PERSONAL PROTECTIVE EQUIPMENT during clean-up.

Accidental Release Measures

Ventilate area, especially low or enclosed places where heavy vapors might collect. Remove open flames. Use self-contained breathing apparatus (SCBA) for large spills or releases.

HANDLING AND STORAGE

Handling (Personnel)

Avoid breathing vapor. Avoid liquid contact with eyes and skin. Use with sufficient ventilation to keep employee exposure below recommended limits. Contact with chlorine or other strong oxidizing agents should also be avoided. See Fire and Explosion Data section.

Storage

Clean, dry area. Do not heat above 52 deg C (125 deg F).

EXPOSURE CONTROLS/PERSONAL PROTECTION

Engineering Controls

Avoid breathing vapors. Avoid contact with skin or eyes. Use with sufficient ventilation to keep employee exposure below the recommended exposure limit. Local exhaust should be used if large amounts are released. Mechanical ventilation should be used in low or enclosed places.

Personal Protective Equipment

Impervious gloves should be used to avoid prolonged or repeated exposure. Chemical splash goggles should be available for use as needed to prevent eye contact. Under normal manufacturing conditions, no respiratory protection is required when using this product. Self-contained breathing apparatus (SCBA) is required if a large release occurs.

Exposure Guidelines

(STABILITY AND REACTIVITY - Continued)

Decomposition

Decomposition products are hazardous. "SUVA" 9000 can be decomposed by high temperatures (open flames, glowing metal surfaces, etc.) forming hydrochloric and hydrofluoric acids and possibly carbonyl halides. These materials are toxic and irritating. Contact should be avoided.

Polymerization

Polymerization will not occur.

TOXICOLOGICAL INFORMATION

Animal Data

The blend is untested.

HFC-125

Inhalation 4 hour ALC: > 709,000 ppm in rats

Single, high inhalation exposures caused lethargy, decreased activity, labored breathing and weight loss. Weak cardiac sensitization effect, a potentially fatal disturbance of heart rhythm caused by a heightened sensitivity to the action of epinephrine. Lowest-Observed-Adverse-Effect-Level for cardiac sensitization: 100,000 ppm. Repeated exposure caused: No significant toxicological effects. No-Observed-Adverse-Effect-Level (NOAEL): 50,000 ppm

No animal data are available to define carcinogenic, developmental or reproductive hazards. In animal testing this material has not caused developmental toxicity. HFC-125 does not produce genetic damage in bacterial or mammalian cell cultures or when tested in animals (not tested for heritable genetic damage).

HFC-134a

Inhalation 4-hour LC50: 567,000 ppm in rats

Single exposure caused: Cardiac sensitization, a potentially fatal disturbance of heart rhythm associated with a heightened sensitivity to the action of epinephrine. Lowest-Observed-Adverse-Effect-Level for cardiac sensitization: 75,000 ppm. Single exposure caused: Lethargy. Narcosis. Increased respiratory rates. These effects were temporary. Single exposure to near lethal doses caused: Pulmonary edema. Repeated exposure caused: Increased adrenals, liver, spleen weight. Decreased uterine, prostate weight. Repeated dosing of higher concentrations caused: the following temporary effects - Tremors. Incoordination.

(TOXICOLOGICAL INFORMATION - Continued)

CARCINOGENIC, DEVELOPMENTAL, REPRODUCTIVE, MUTAGENIC EFFECTS:

In a two-year inhalation study, HFC-134a, at a concentration of 50,000 ppm, produced an increase in late-occurring benign testicular tumors, testicular hyperplasia and testicular weight. The no-effect-level for this study was 10,000 ppm. Animal data show slight fetotoxicity but only at exposure levels producing other toxic effects in the adult animal. Reproductive data on male mice show: No change in reproductive performance. Tests have shown that this material does not cause genetic damage in bacterial or mammalian cell cultures, or in animals. In animal testing, this material has not caused permanent genetic damage in reproductive cells of mammals (has not produced heritable genetic damage).

HFC-32

Inhalation: 4 hour-ALC: > 520,000 ppm in rats

Single exposure caused: Lethargy. Spasms. Loss of mobility in the hind limbs. Other effects include weak cardiac sensitization, a potentially fatal disturbance of heart rhythm caused by a heightened sensitivity to the action of epinephrine. 250,000 ppm.

Repeated exposure caused pathological changes of the lungs, liver, spleen, kidneys. In more recent studies repeated exposure caused: No significant toxicological effects. No-Observed-Effect-Level (NOEL): 49,100 ppm.

No animal data are available to define the following effects of this material: carcinogenicity, reproductive toxicity. Animal data show slight fetotoxicity but only at exposure levels producing other toxic effects in the adult animal. Tests have shown that this material does not cause genetic damage in bacterial or mammalian cell cultures, or in animals. This material has not been tested for its ability to cause permanent genetic damage in reproductive cells of mammals (not tested for heritable genetic damage).

ECOLOGICAL INFORMATION

Ecotoxicological Information

HFC-134a

48-hour EC50, Daphnia magna: 980 mg/L
96-hour LC50, Rainbow trout: 450 mg/L

DISPOSAL CONSIDERATIONS

Waste Disposal

Comply with Federal, State, and local regulations. Reclaim by distillation or remove to a permitted waste disposal facility.

TRANSPORTATION INFORMATION

Shipping Information

DOT/IMO/IATA
Proper Shipping Name : Refrigerant Gas R407C
Hazard Class : 2.2
UN No. : 3340
Label(s) : Nonflammable Gas

Shipping Containers

Tank Cars.

Cylinders
Ton Tanks

REGULATORY INFORMATION

U.S. Federal Regulations

TSCA Inventory Status : Reported/Included.

TITLE III HAZARD CLASSIFICATIONS SECTIONS 311, 312

Acute : Yes
Chronic : Yes
Fire : No
Reactivity : No
Pressure : Yes

LISTS:

SARA Extremely Hazardous Substance -No
CERCLA Hazardous Substance -No
SARA Toxic Chemical -No

OTHER INFORMATION

NFPA, NPCA-HMIS

NPCA-HMIS Rating
Health : 1
Flammability : 0
Reactivity : 1

Personal Protection rating to be supplied by user depending on use conditions.

Additional Information

MEDICAL USE: CAUTION: Do not use in medical applications involving permanent implantation in the human body. For other medical applications see DuPont CAUTION Bulletin No. H-50102.

The data in this Material Safety Data Sheet relates only to the specific material designated herein and does not relate to use in combination with any other material or in any process.

Responsibility for MSDS : MSDS Coordinator
> : DuPont Fluoroproducts
Address : Wilmington, DE 19898
Telephone : (800) 441-7515

Indicates updated section.

This information is based upon technical information believed to be reliable. It is subject to revision as additional knowledge and experience is gained.

End of MSDS

Controller Operation Guide (S-Series)



Keypad Functions:

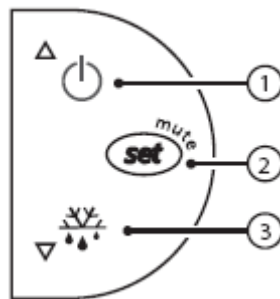

Figure 1

Button 1 (Up Arrow):

Pressing this button raises the selected value.

Button 2 (Set):

Pressing this button for 1 second allows access to the “set-point” of the chiller.

Pressing this button for 3 seconds will allow access to the “set-point differential”, “password” and “°C/ °F” of the chiller.

Button 3 (Down Arrow):

Pressing this button lowers the selected value.

***Note: Password is used to access additional parameters in the controller. This should only be accessed by a certified technician.**

Changing the “set-point”:

To change the “set-point”, hold the “Set” key (see Keypad Functions) for 1 second until you see the letters ‘st’. Then press the set key again to access the set-point. Use the “Up Arrow” and “Down Arrow” keys to change the value. Once to the desired value, press the “Set” key again to store the value.

***Note: The set-point can be set between 50°F and 90 °F**

Changing the “set-point differential”:

To change the “set-point differential”, hold the “Set” key (see Keypad Functions) for 3 seconds until you see the letters ‘Pw’. Then use the arrow keys to scroll through the menus until you see the letters ‘rd’. Then press the set key again to access the set-point differential. Use the “Up Arrow” and “Down Arrow” keys to change the value. Once to the desired value, press the “Set” key again to store the value.

***Note: The set-point differential should be set between 3°F and 10 °F**

Changing the temperature display (°C/ °F):

To change the temperature display, hold the “Set” key (see Keypad Functions) for 3 seconds until you see the letters ‘Pw’. Then use the arrow keys to scroll through the menus until you see ‘/5’ on the display. Then press the set key again to access the display settings. Use the “Up Arrow” and “Down Arrow” keys to change the value.

***Note:** 0 = °C, 1 = °F

Controller Operation:

When power is applied to the controller the temperature of the sensor in the piping is displayed. If the temperature rises above the set-point (st) by the set-point differential (rd), the compressor is turned on. Once the temperature reaches the set-point the compressor is turned off. See **Figure 2** below:

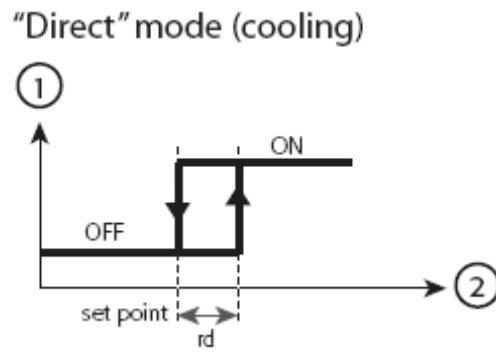

Figure 2

NOTE:
 ALL INTERCONNECTING
 PLUMBING TO BE RUN
 IN POLYPROPYLENE MATERIAL,
 OTHERWISE CONTACT
 ENGINEERING, BOM
 COMPONENTS EXCLUDED.

-NOTICE-
 FOR WELD PACKAGE
 UNITS, USE 0611708
 AND 0611707

-NOTICE-
 MAINTAIN WATER/
 GLYCOL MIXTURE AT
 NO MORE THAN 50%
 GLYCOL AND NO LESS
 THAN 30% GLYCOL

SEE FRONT OF
 FOLDER FOR NON
 STOCK OPTIONS.

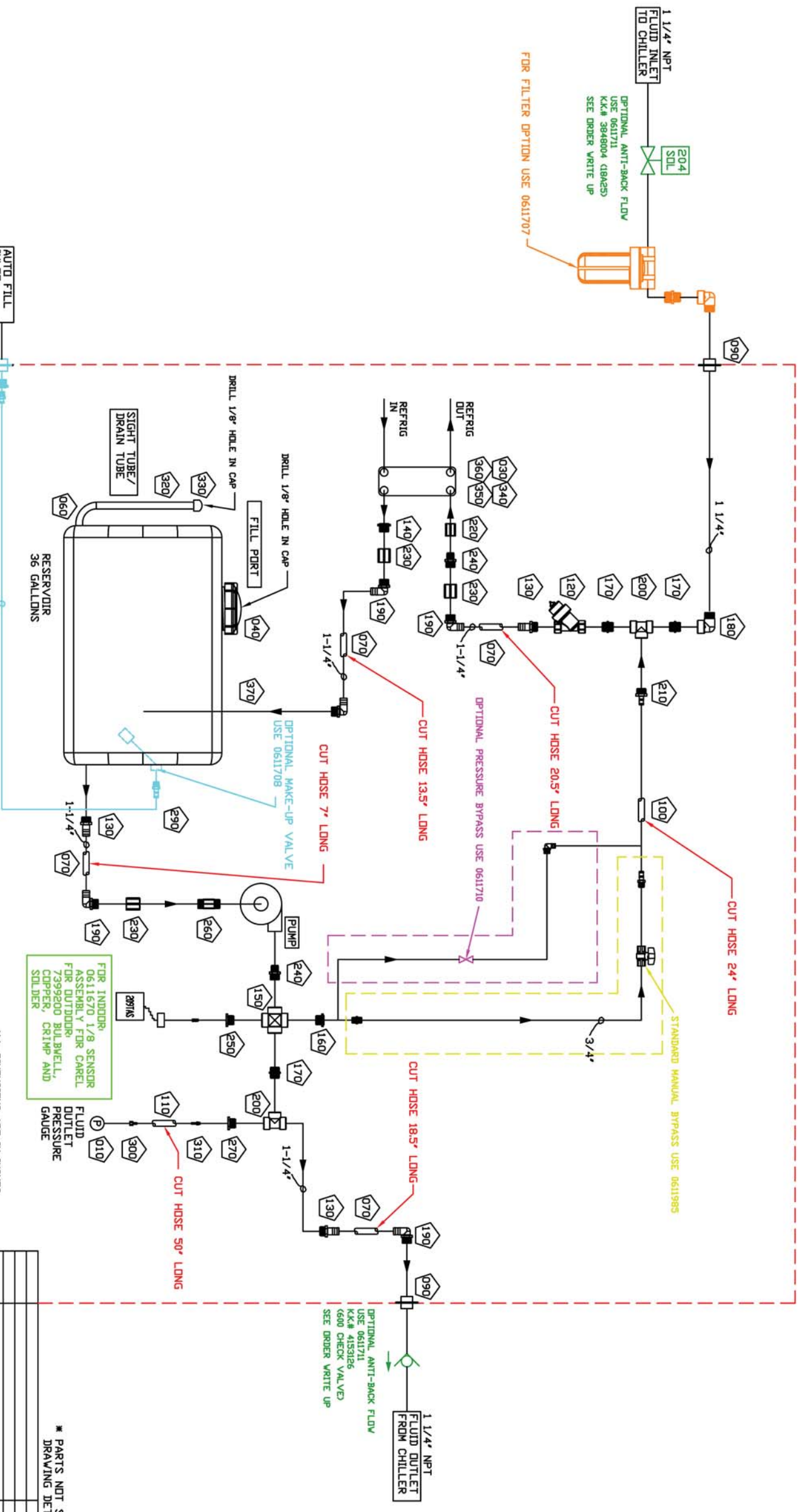

NOTE:
 PLUG TANK WITH KK# 7410193 3/4 POLY PIPE
 PLUG ON ALL UNITS NOT EQUIPPED WITH AN
 AUTO-FILL OPTION.

* PARTS NOT SHOWN ON
 DRAWING DETAIL

ALL DIMENSIONS ARE IN INCHES

THIS PRINT MAY NOT BE
 DUPLICATED, REPRODUCED, OR SHARED IN ANY WAY
 WITHOUT EXPRESSED WRITTEN CONSENT

CONFIDENTIAL AND PROPRIETARY

IND.	ID/DESCRIPTION	K. K. PART#	QTY	TYPE
------	----------------	-------------	-----	------

001	MC 5T PIPING	0437656	1.0	PC
010	GAUGE PIPING CBN 0-100 PSIZO-7 BAR WITH MOUNTING BRACKET (ORDER 42431 03 YY-L-07 BKTD) SS, 1/4 MPT BRASS, LIQUID FILLED	4243100	1.0	PC
020	50200 HOSE CLAMP 1-1/4 - 2-1/8	7797411	6.0	PC
030	IDEAL SS K095#308 - BRAZED PLATE H/E 4-5 TON AT/2P 7/8\" SOLDER 1/2-1\" MPT 36 GALLON PLASTIC TANK 31-ST FROMENS, INCLUDES CAP, MATEL LUDPE 1 WALL THICKNESS = .750 WGT 24.2 62020SE HOSE CLAMP 7/32 - 5/8 SS BREZLE	2200505	1.0	PC
040	4514001	4514001	1.0	PC
050	7797410	7797410	2.0	PC
060	4400017	4400017	2.0	PC
070	4410003	4410003	6.5	PC
080	7797200	7797200	2.0	PC
090	0438338	0438338	2.0	ASSEN
010	0437991	0437991	1.0	ASSEN
020	9521260	9521260	0.3	PC
030	7210201	7210201	1.0	PC
100	4400106	4400106	1.5	PC
110	4400001	4400001	4.0	PC
120	2900207	2900207	1.0	PC
130	7410174	7410174	3.0	PC
140	7410179	7410179	1.0	PC
150	7410176	7410176	1.0	PC
160	7410177	7410177	3.0	PC
170	7410178	7410178	1.0	PC
180	7410180	7410180	4.0	PC
190	7410184	7410184	2.0	PC
200	7410175	7410175	1.0	PC
210	7410229	7410229	1.0	PC
220	7410181	7410181	1.0	PC
230	7410183	7410183	3.0	PC
240	7410188	7410188	2.0	PC
250	0441381	0441381	1.0	ASSEN
010	7410194	7410194	1.0	PC
260	7410190	7410190	1.0	PC
270	0438952	0438952	1.0	ASSEN
010	7410194	7410194	1.0	PC
280	3802413	3802413	1.0	PC
290	7410193	7410193	1.0	PC
300	7502912	7502912	1.0	PC
310	7501901	7501901	1.0	PC
320	7404801	7404801	1.2	PC
330	7404902	7404902	1.0	PC
340	0441222-1	0441222-1	1.0	PC
350	0441223-2	0441223-2	1.0	PC
360	0441222-3	0441222-3	1.0	PC
370	0441826	0441826	1.0	ASSEN
010	0441826-1	0441826-1	1.0	ASSEN
020	7410184	7410184	1.0	PC
030	0441826-2	0441826-2	1.0	ASSEN
010	0441826-3	0441826-3	1.0	PC
030	4650104	4650104	0.0	ASSEN

OPTIONAL ANTI-BACK FLOW
 USE 0611711
 KK# 415316
 6500 CHECK VALVES
 SEE ORDER WRITE UP

OPTIONAL ANTI-BACK FLOW
 USE 0611711
 KK# 415316
 6500 CHECK VALVES
 SEE ORDER WRITE UP

OPTIONAL ANTI-BACK FLOW
 USE 0611711
 KK# 415316
 6500 CHECK VALVES
 SEE ORDER WRITE UP

OPTIONAL ANTI-BACK FLOW
 USE 0611711
 KK# 415316
 6500 CHECK VALVES
 SEE ORDER WRITE UP

OPTIONAL ANTI-BACK FLOW
 USE 0611711
 KK# 415316
 6500 CHECK VALVES
 SEE ORDER WRITE UP

OPTIONAL ANTI-BACK FLOW
 USE 0611711
 KK# 415316
 6500 CHECK VALVES
 SEE ORDER WRITE UP

OPTIONAL ANTI-BACK FLOW
 USE 0611711
 KK# 415316
 6500 CHECK VALVES
 SEE ORDER WRITE UP

OPTIONAL ANTI-BACK FLOW
 USE 0611711
 KK# 415316
 6500 CHECK VALVES
 SEE ORDER WRITE UP

DATE	DESCRIPTION OF REVISION	APPROVED BY
7/20/09	ADDED DRILL HOLE IN SIGHT GLASS AND TANK CAP	

DESIGN BY: JIU	DRAWN BY: JIU
DATE: 7/20/09	PAGE 1 OF 1
MC 5T	
PIPING	
DRAWING NO:	437656



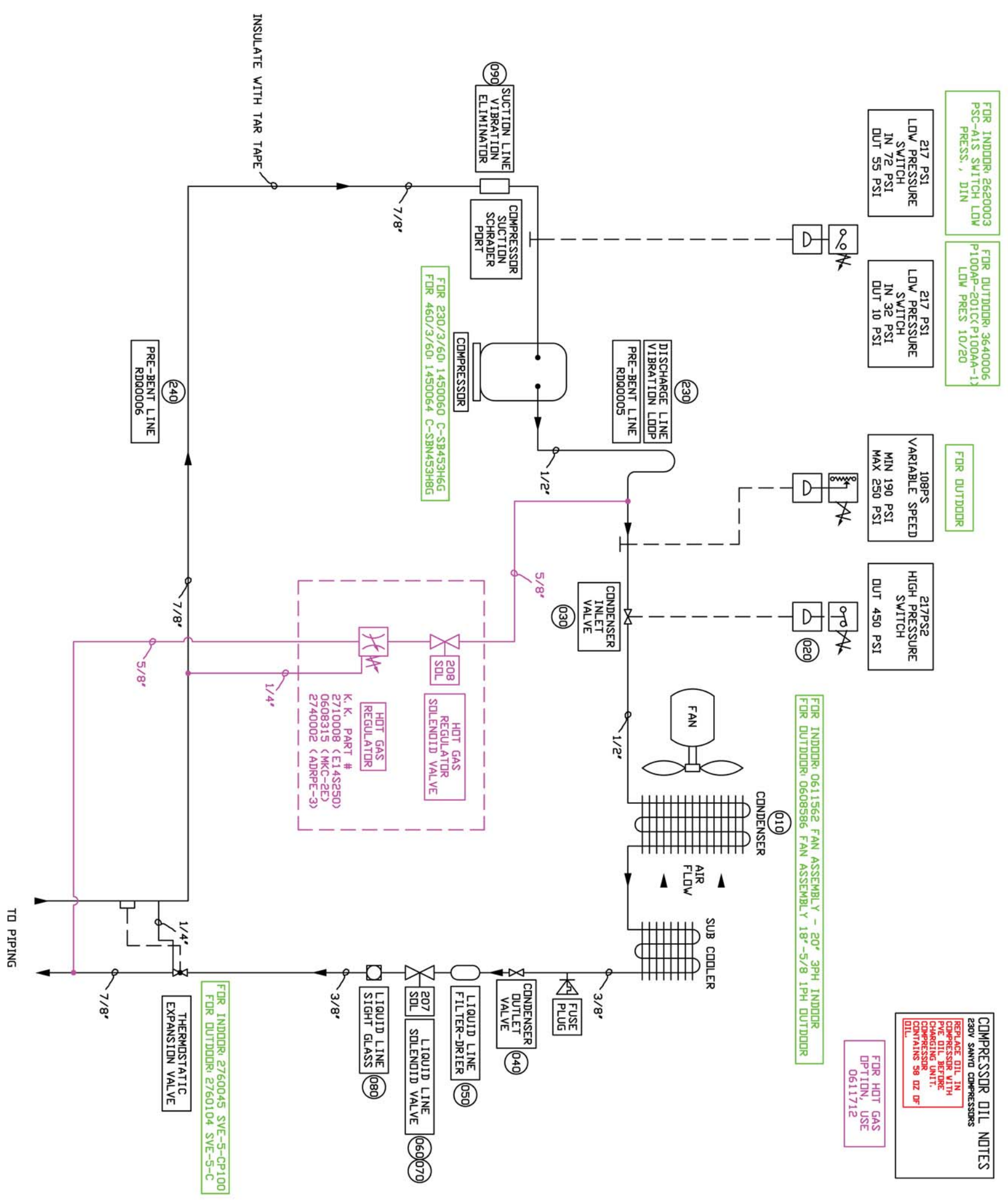

FOR INDOOR: 2620003
PSC-AIS SWITCH LOW
PRESS., DIN

FOR OUTDOOR: 3640006
P100AP-201CX P100AA-1X
LOW PRES. 10/20

217 PSI
LOW PRESSURE
SWITCH
IN 72 PSI
OUT 55 PSI

217 PSI
LOW PRESSURE
SWITCH
IN 32 PSI
OUT 10 PSI

108PS
VARIABLE SPEED
MIN 190 PSI
MAX 250 PSI

217PS2
HIGH PRESSURE
SWITCH
OUT 450 PSI

FOR INDOOR: 0611562 FAN ASSEMBLY - 20" 3PH INDOOR
FOR OUTDOOR: 0608586 FAN ASSEMBLY 18"-5/8 1PH OUTDOOR

COMPRESSOR OIL NOTES
230V SAND COMPRESSORS
REPLACE OIL IN
COMPRESSOR WITH
ONE OIL BEFIRE
STARTING UNIT.
COMPRESSOR
CONTAINS 98 OZ OF
OIL.

FOR HOT GAS
OPTION, USE
0611712

SEE FRONT OF
FOLDER FOR NON
STOCK OPTIONS.

REFRIGERATION PARTS

NO.	DESCRIPTION	K.K. PART #	QTY.	TYPE
001	MC 5T REFRIG.	0437658	1.0	ASSEN
010	COIL MC 3-5 TON 3 ROW COIL .5" PATTERNED FROM COIL CCCC028384-AAS4	1413135	1.0	PC
020	4-0021 (C BUT ONLY 3 ROWS) SWITCH HIGH PRESSURE 450 MANUAL VENDOR PART NUMBER: YK-03H 0110-45 08350Z/KRS ENCAPSULATED WITH A 9 FT DI CORD/DRS HIGH MANUAL RESET. DENS 450 PSL 10/2/404A HP SWITCH. RESURGE DISTRIBUTION VALVE ANGLE REFRIG 1/2 VALVE ANGLE REFRIG 3/8 VALVE ANGLE REFRIG 3/8 WITH ACCESS PORT C-1635 FILTER DRIER 3/8"	3640017	1.0	PC
030	VALVE ANGLE REFRIG 1/2	3980001	1.0	PC
040	VALVE ANGLE REFRIG 3/8	3980000	1.0	PC
050	WITH ACCESS PORT	2730030	1.0	PC
060	SPRIRLAN	2710025	1.0	PC
070	REQUIRES MKC-2E COIL SPRIRLAN	0608315	1.0	ASSEN
010	MKC-2E 120V 50-60 HZ COIL ASSEMBLY MKC-2E SOLENOID COIL 120V 50-60 DIN ASSEMBLY WITH CABLE IS 0608315 SP DRLAN	2710110	1.0	PC
020	1220S CONNECTOR: DIN 43650 18MM W/ 5 METER GRAY PVC CABLE AC/DC 0-230 V 18 GA WIRE LUL RECOGNIZED E172930 MURBEL ETRONIK NEW PART NUMBER 7000-18081-2180900 SA-135 SIGHT GLASS 3/8 DWF (R146-1) SPEIRLAN	4807100	1.0	PC
080	2720002	2720002	1.0	PC
090	VAP-8 VIBRATION ELIMINATOR 7/8	2980008	1.0	PC
100	016M019 CLAMP 1	2980045	1.0	PC
110	008M011 CLAMP 1/2	2980022	1.0	PC
120	INSULATION TAPE GASKET .25 X 2 X 50 NITRILE/PVC BLEND, CLOSED CELL SPD NGE RUBBER, TEMPERATURE RANGE: -20 TD 160F, INTERMITTENT 250F, CAN BE USED AT 200F CONTINUOUS PER GRR. G R RUBBER PRODUCTS 1011-30 GASKET EPDM (SV SERIES) 60 DEGEE +- 5 SHORE A BLACK. 33M M DRIER IN 164 FT ROLLS VCT-2 BULK CORK INSULATION TAPE KMD / PH 12 ROLLS PER CASE A-4544 SEAL CAP 36"-4	4449009	0.0	PC
130	VALVE CORE	7502953	1.0	PC
140	100 CT / PK ***** EQUIV. TO SCH RAIDER # 805 70	4457004	5.2	PC
150	TUBING 1/4 SOFT COPPER REFRIG. TUBING 3/8 SOFT COPPER REFRIG	4450000	0.0	PC
160	50' ROLL	7613100	5.0	PC
170	TUBING 5/8 SOFT COPPER REFRIG.	7305000	0.1	PC
180	Y-2634 ELBOW 90 7/8 FTG X FTG SR	7307340	2.0	PC
190	Y-4041 TEE 7/8 X 5/8 X 7/8 C	7307402	1.0	PC
200	Y-2321 ELBOW 90 1/2 FTG X C SR	7304320	1.0	PC
210	PRE-BENT LINE RD000005	7399034	1.0	PC
220	PRE-BENT LINE RD000005	7399035	1.0	PC
230	PRE-BENT LINE RD000006	2990030	7.0	PC
240	REFRIGERANT R407C IN A 115LB CYL			
250				

* PARTS NOT SHOWN ON
DRAWING DETAIL

ALL DIMENSIONS ARE IN INCHES
THIS PRINT MAY NOT BE
DUPLICATED, REPRODUCED, OR SHARED IN ANY WAY
WITHOUT EXPRESSED WRITTEN CONSENT
CONFIDENTIAL AND PROPRIETARY

DATE	DESCRIPTION OF REVISION	APPROVED BY
11/02/09	CHANGED HIGH PRESSURE SWITCH	JH

DESIGN BY: JIU
DATE: 10/23/08

DRAWN BY: JIU
PAGE 1 OF

MC 5T

REFRIGERATION

DRAWING NO: 437658

